

Description

These series range of General Purpose filters are designed to suppress undesirable electrical disturbances in Power Lines. They limit the amplitude of interfering voltages on AC power lines and prevent them from propagating into or out of the filtered equipment.

Features

- Rated Current up to 125A
- Medical Version available
- High Conducted attenuation performance
- Chassis mounting



Applications

- Power Systems
- Electronic Equipment
- Frequency convertors
- Stepper motor drives
- UPS/Inverters

Approvals & Compliance



Typical circuit Diagram

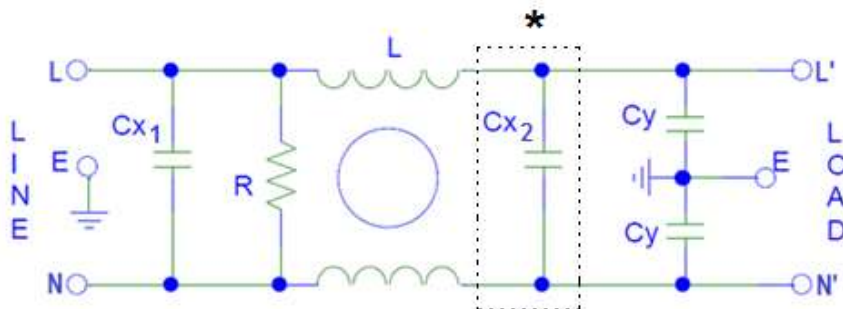



* Above 20Amps Cx2 capacitor will be included in the circuit

Technical Specifications

Maximum Continuous Operating Voltage	: 250VAC
Operating Frequency	: 50/60Hz
Current ratings	: 1A to 125A @40°C
High Potential test voltage	: L to G 2250Vdc for 1 Minute L to L 1450Vdc for 1 Minute
Overload Capability	: 135% of Rated current for 15 minutes
Design Corresponding to	: UL1283, CSA 22.2 No.8-13 and IEC 60939
Flammability corresponding to	: UL 94 V-0
Temperature range	: -25°C to +85°C
Climatic Category	: 25/85/21

Image shown above is just for reference

Selection Table

Part Number	Ordering Code	Rated Current @40°C	Leakage Current @250VAC/50Hz (mA)	Termination		Weight (Kgs)
						
MF420 – 01	S420000001S	1A	0.34	6.3 x 0.8		0.06
MF420 – 02	S420000002S	2A*	0.34	6.3 x 0.8		0.06
MF420 – 03	S420000003S	3A	0.34	6.3 x 0.8		0.06
MF420 - 06	S420000006S	6A	0.34	6.3 x 0.8		0.06
MF420 - 10	S420000010S	10A	0.34	6.3 x 0.8		0.06
MF420 - 15	S420000015S	15A	0.34	6.3 x 0.8		0.125
MF420 - 16	S420000016S	16A*	0.34	6.3 x 0.8		0.125
MF420 - 20	S420000020S	20A	0.34	6.3 x 0.8		0.260
MF420 - 25	S420000025N	25A*	0.73		M5	0.6
MF420 - 30	S420000030N	30A	0.73		M5	0.6
MF420 - 35	S420000035N	35A*	0.73		M5	0.6
MF420 - 40	S420000040N	40A	0.73		M5	0.6
MF420 - 50	S420000050N	50A	0.73		M6	1
MF420 - 60	S420000060N	60A*	0.73		M6	1
MF420 - 75	S420000075N	75A*	0.73		M8	2
MF420 - 80	S420000080N	80A*	0.73		M8	2
MF420 - 100	S420000100N	100A*	0.73		M10	2
MF420 - 125	S420000125N	125A*	0.73		M10	3

Note: * Not covered under NEMKO

Customized filters are provided on request.

1 to 10A Types

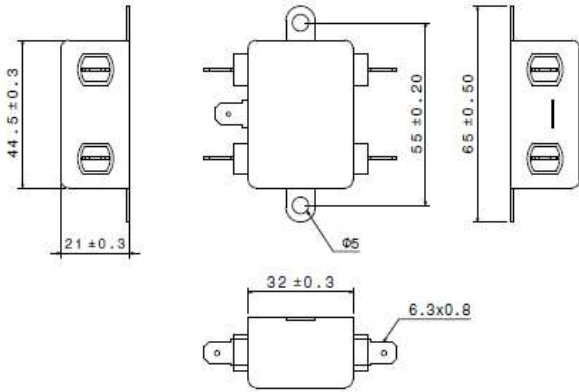

Material/Finish : CRCA/Nickel Plating

15A & 16A Types

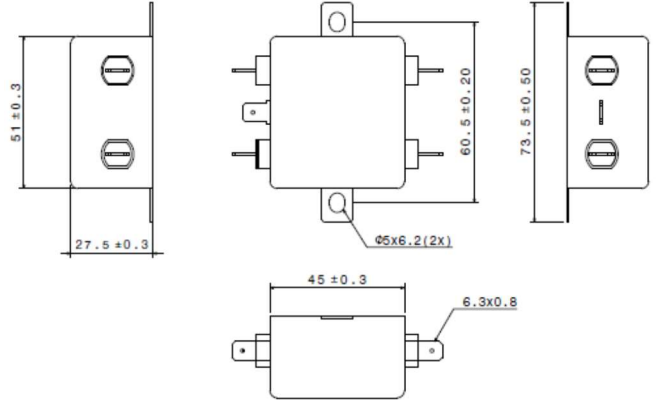

Material/Finish : CRCA/Nickel Plating

20A Type

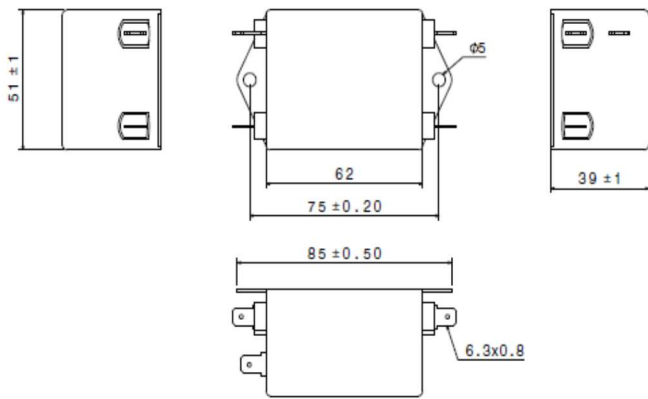

Material/Finish : CRCA/Nickel Plating

25A to 40A Types

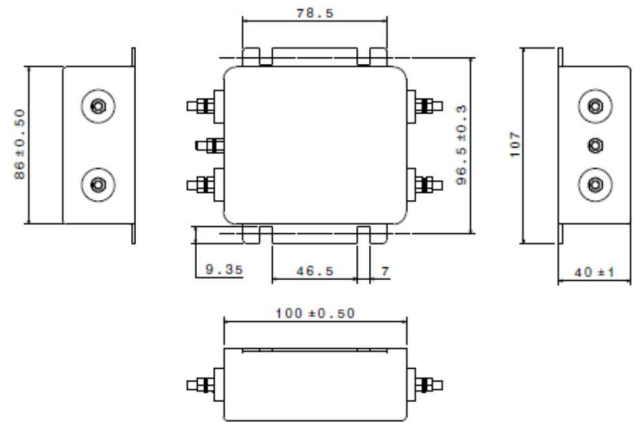

Material/Finish : CRCA/Nickel Plating

50A to 60A Types

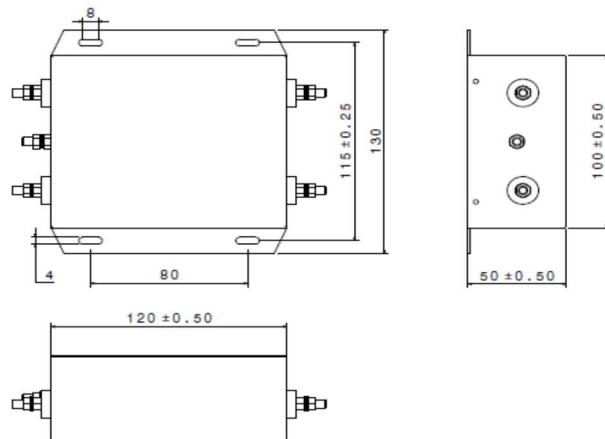

Material : Aluminium

75A to 125A Types

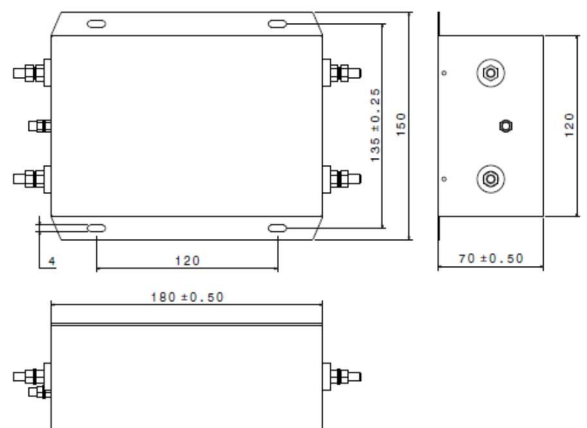

Material : Aluminium

Thread Size	M5	M6	M8	M10
Recommended Torque (Nm)	2-3	3.5-4	10-14	15-17

All dimensions in mm; Tolerances according to ISO2768-m

Insertion Loss – (Common Mode)

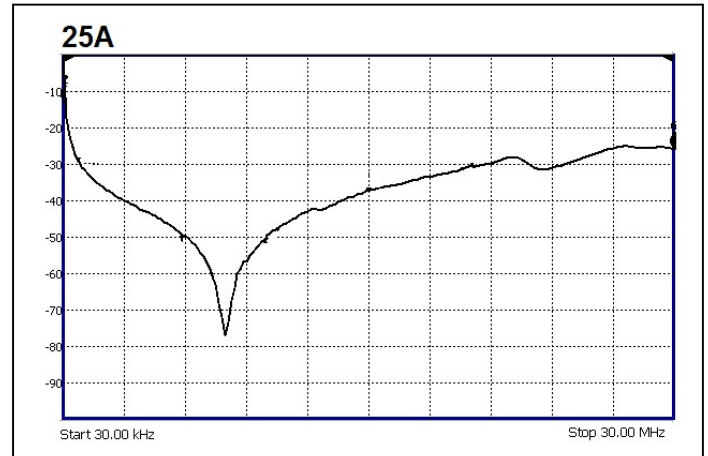
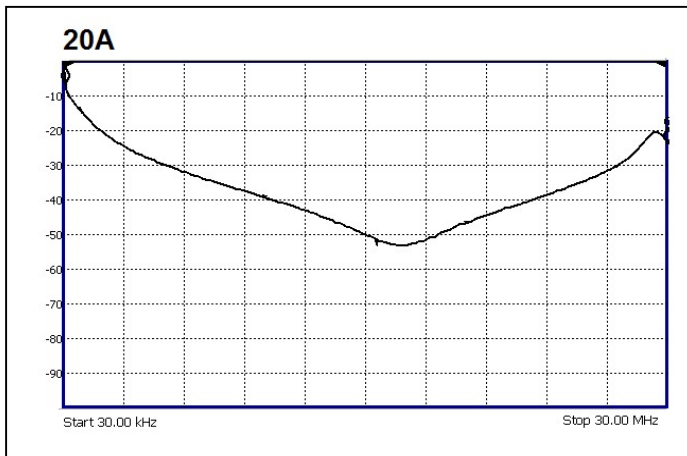
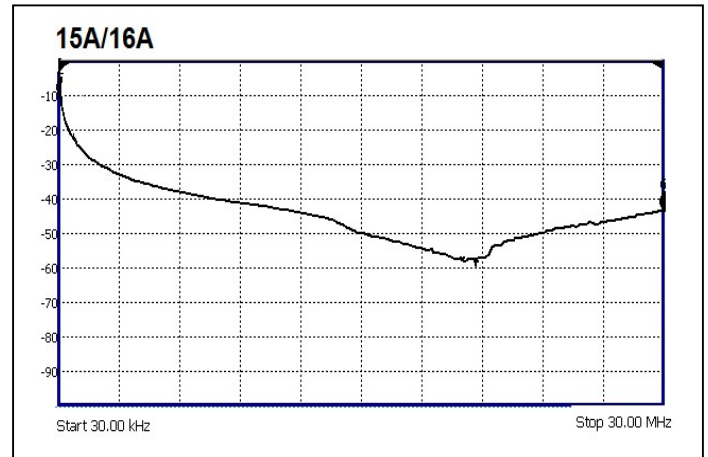
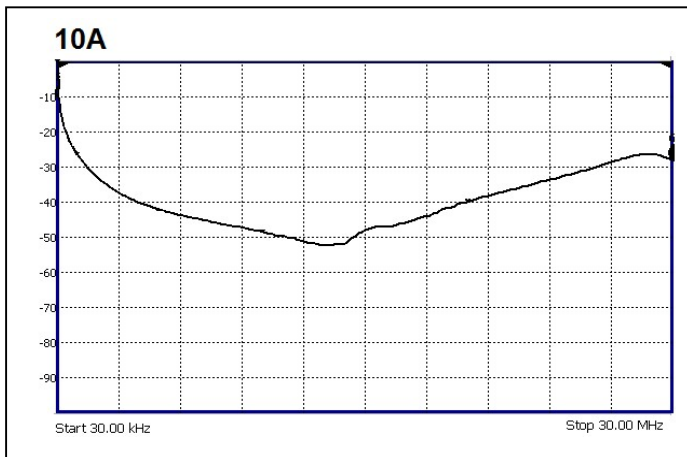
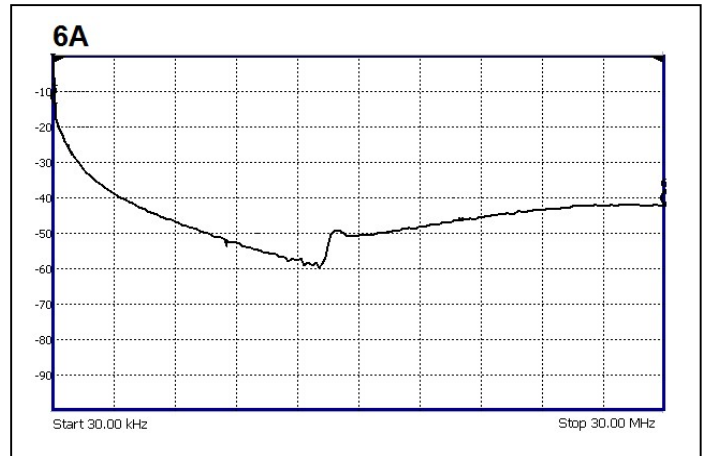
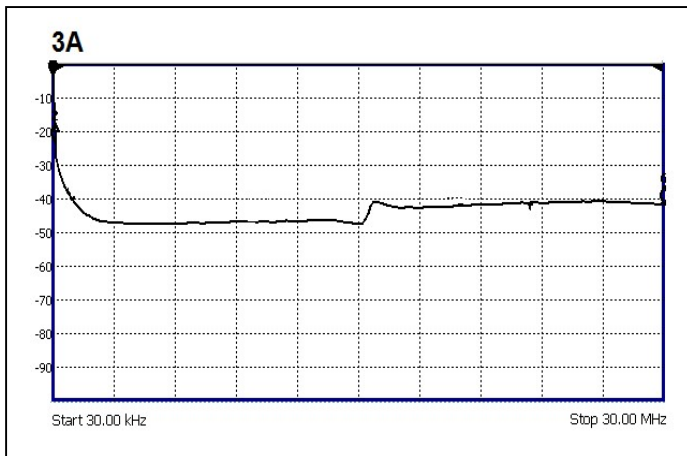
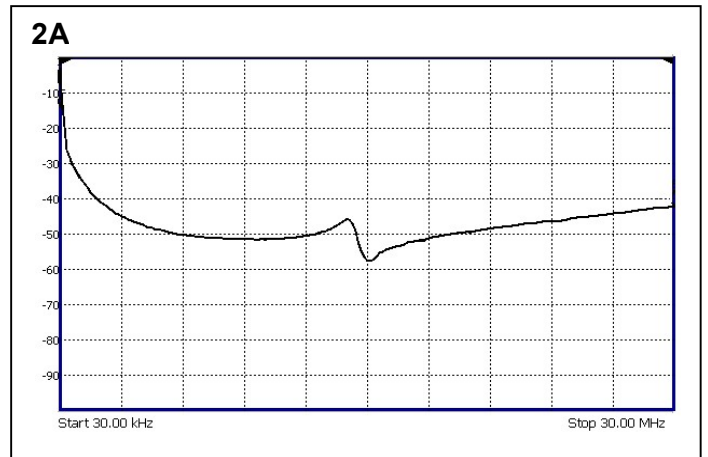
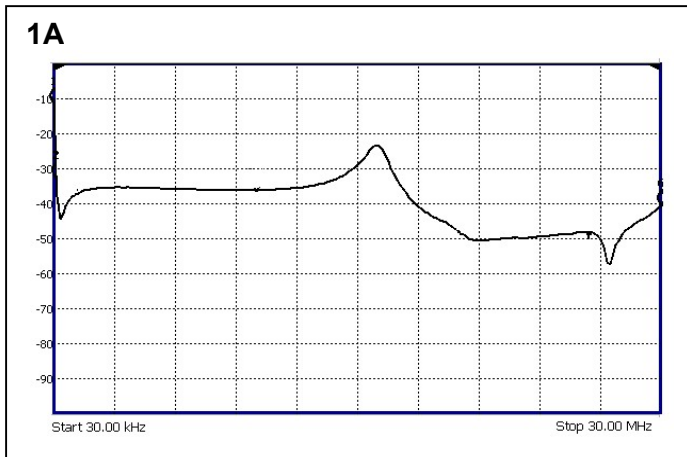

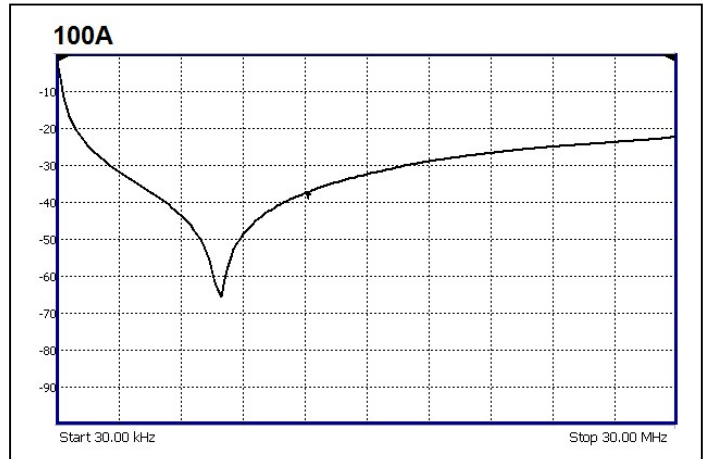
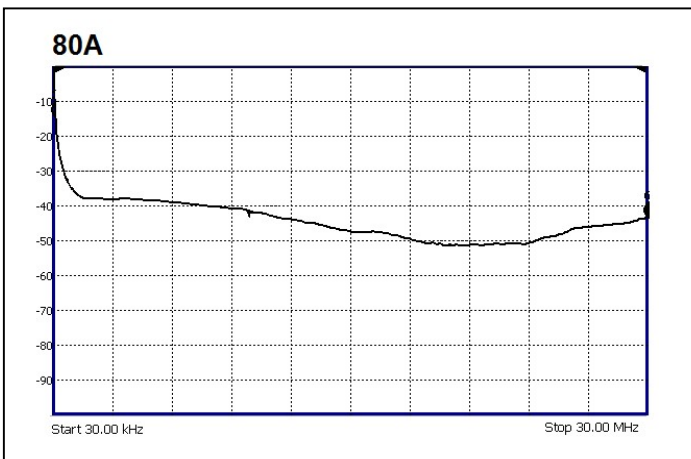
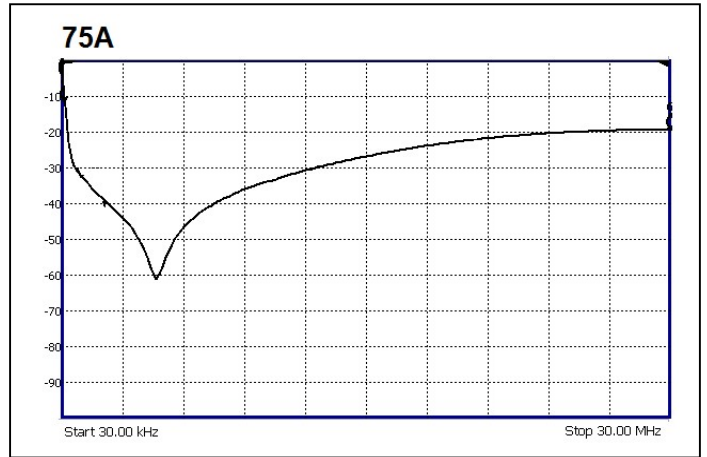
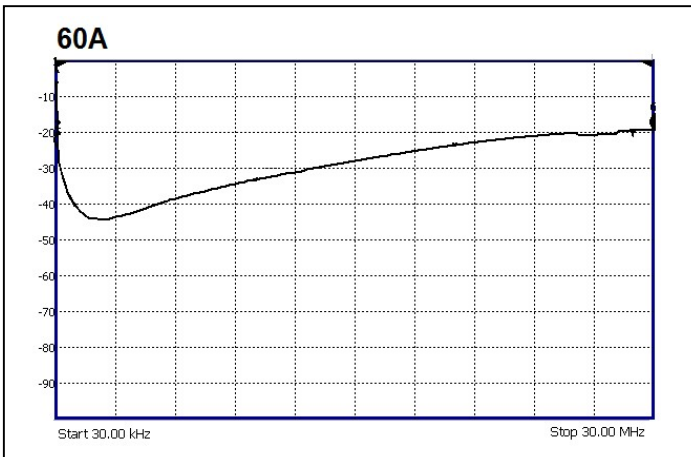
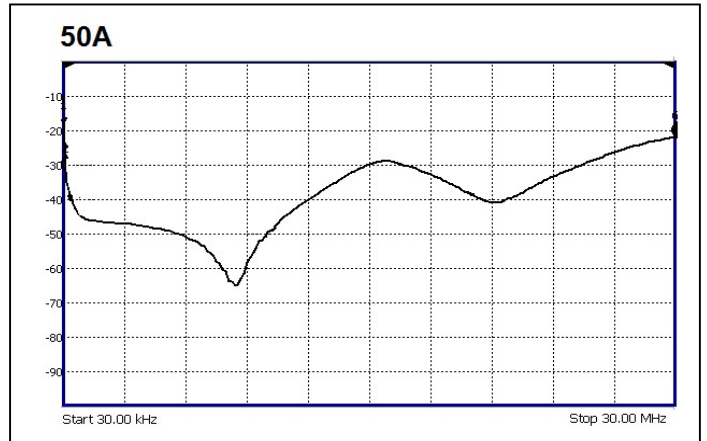
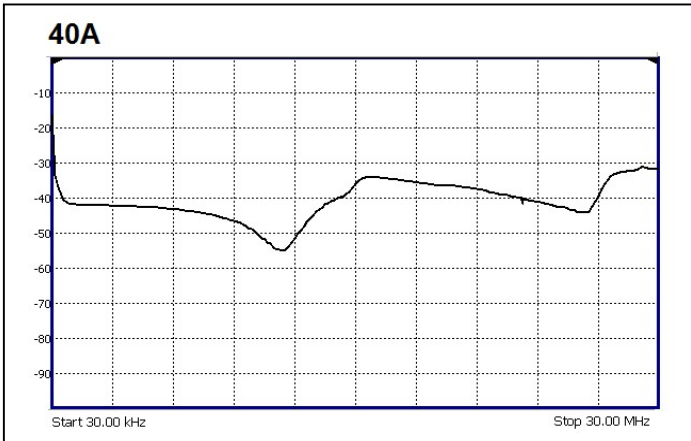
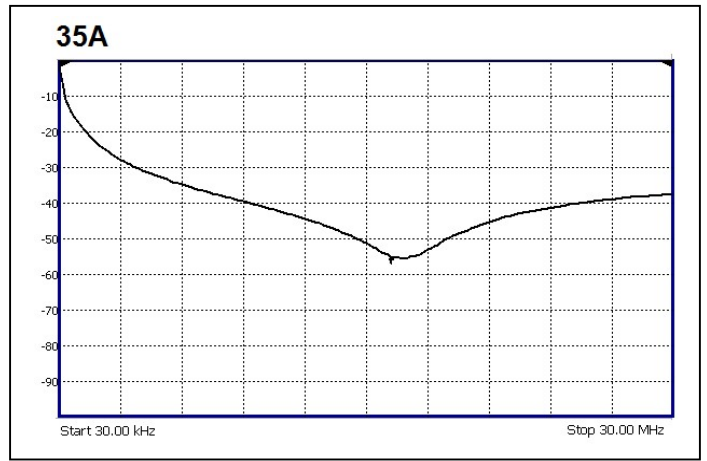
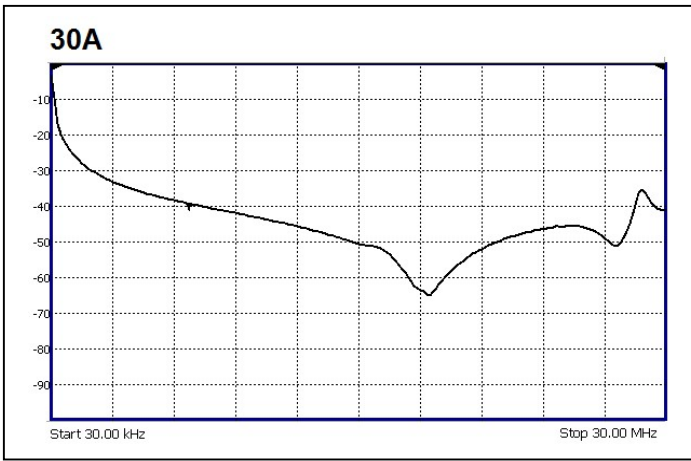

125A

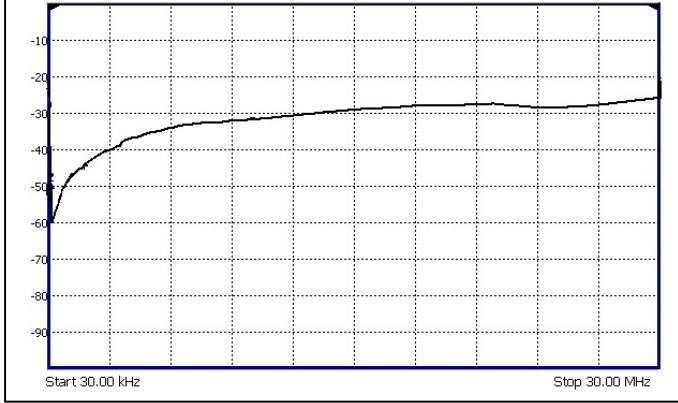

EMI Solutions Pvt Ltd

#237-A5, Bommasandra Industrial Area, Bangalore-560099,
Marketing: +91 80 27836880, Email: marketing@emisindia.com