

Description

These series range of three phase filters with neutral designed to use in wide range of applications. Give superior performance when used in applications with low Impedance load controlling pulsed, continuous and intermittent interference noise and where high levels of mains borne interference are present.

Features

- Compact
- Good Attenuation Performance
- Chassis mounting 3 Phase Filter with neutral

Applications

- CNC Machines
- Drives
- Convertors
- Rectifier
- HVAC



Approvals & Compliance



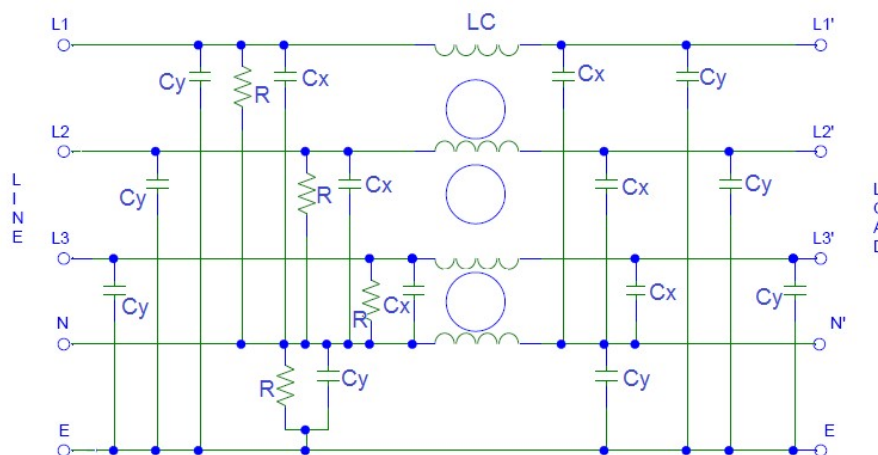

Typical circuit Diagram



Technical Specifications

Maximum Continuous Operating Voltage	: 440/520VAC
Operating Frequency	: 50/60Hz
Current ratings	: 6A to 250A @40°C
High Potential test voltage	: L to G 2660Vdc for 1 Minute L to L 1950Vdc for 1 Minute
Overload Capability	: 135% of Rated current for 15 minutes
Design Corresponding to	: UL 60939-3, CSA 22.2 No.8-13 and IEC 60939
Flammability corresponding to	: UL 94 V-0
Temperature range	: -25°C to +85°C
Climatic Category	: 25/85/21
Enclosure Material	: Aluminium

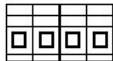
Selection Table

Part Number	Ordering Code (For 440VAC)	Ordering Code (For 520VAC)	Rated Current @40°C	Termination		Weight (Kgs)
						
MF 423 4 2D	S42D000006C	S42D520006C	6A	41		1
MF 423 4 2D	S42D000008C	S42D520008C	8A*	41		2
MF 423 4 2D	S42D000010C	S42D520010C	10A*	41		2
MF 423 4 2D	S42D000015C	S42D520015C	15A*	41		3
MF 423 4 2D	S42D000016C	S42D520016C	16A	41		3
MF 423 4 2D	S42D000020C	S42D520020C	20A*	41		3
MF 423 4 2D	S42D000025C	S42D520025C	25A	41		3
MF 423 4 2D	S42D000036C	S42D520036C	36A	10		4
MF 423 4 2D	S42D000050C	S42D520050C	50A	10		4
MF 423 4 2D	S42D000060C	S42D520060C	60A	16		8
MF 423 4 2D	S42D000075C	S42D520075C	75A	16		8
MF 423 4 2D	S42D000080C	S42D520080C	80A*	25		9
MF 423 4 2D	S42D000100C	S42D520100C	100A*	25		9
MF 423 4 2D	S42D000125N	S42D520125N	125A*		M10	10
MF 423 4 2D	S42D000150N	S42D520150N	150A*		M10	10
MF 423 4 2D	S42D000160N	S42D520160N	160A*		M10	10
MF 423 4 2D	S42D000170N	S42D520170N	170A*		M10	10
MF 423 4 2D	S42D000200N	S42D520200N	200A*		M10	11
MF 423 4 2D	S42D000250N	S42D520250N	250A*		M10	11

Note: * not covered under NEMKO

Filters with 520VAC are not covered under NEMKO

Connectors Cross Sections

	41	10	16	25
Wire Section (mm ²)	4mm ²	10 mm ²	16 mm ²	25 mm ²
Wire Section (AWG)	12AWG	8 AWG	6 AWG	4 AWG
Wire Stripping	Max 10mm	max 13.5 mm	max 17 mm	max 17 mm
Max Recommended Torque	0.5 Nm / 4.5 in.lbs	1.2 Nm / 10.8 in.lbs	2÷2.2 Nm / 18÷19.8 in.lbs	2 Nm / 18 in.lbs

For Screw Type Connections

Thread Size	M10
Recommended Torque (Nm)	4-10

6A Types

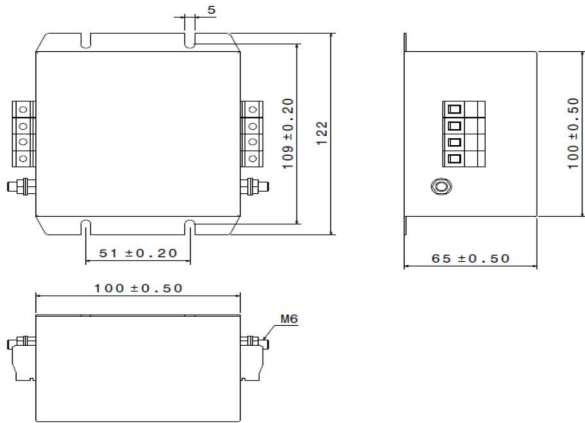

8A to 10A Types

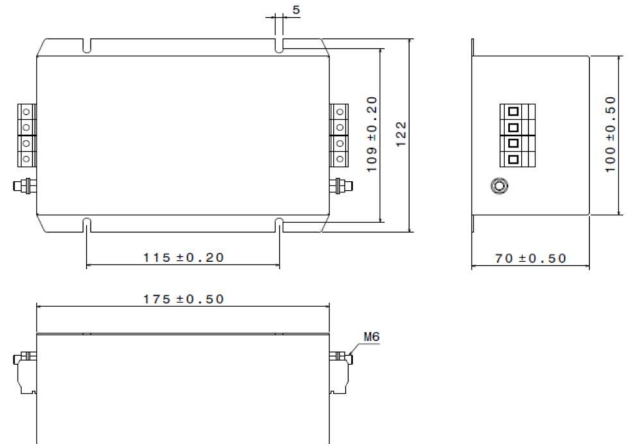

15A to 50A Types

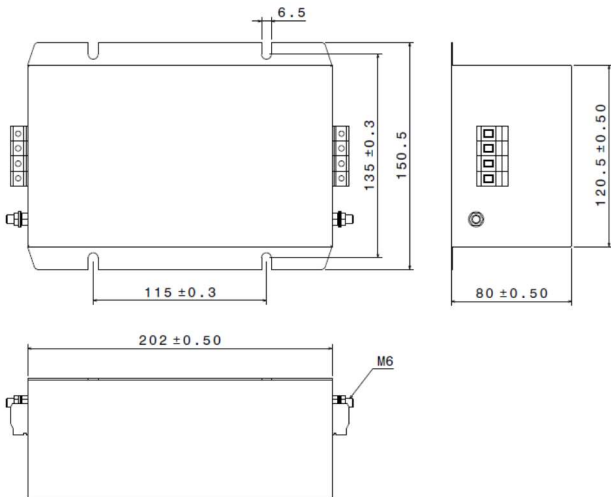

60A to 100A Types

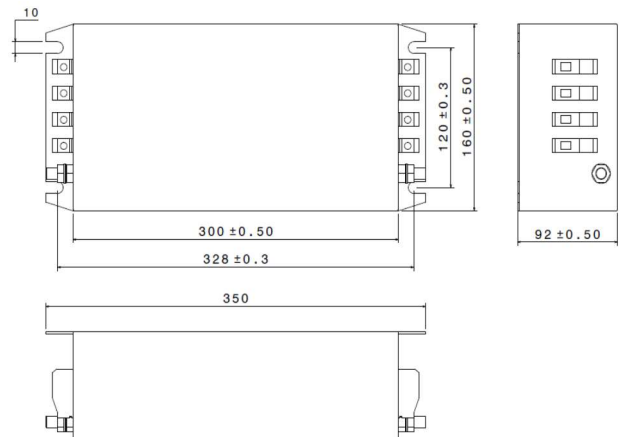

125A to 160A Types

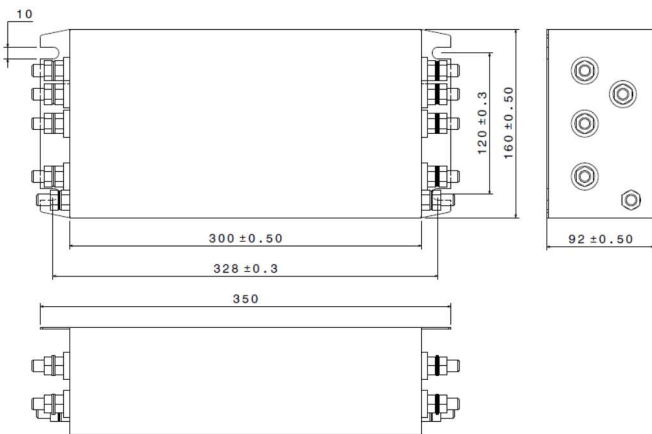

170A to 250A Types

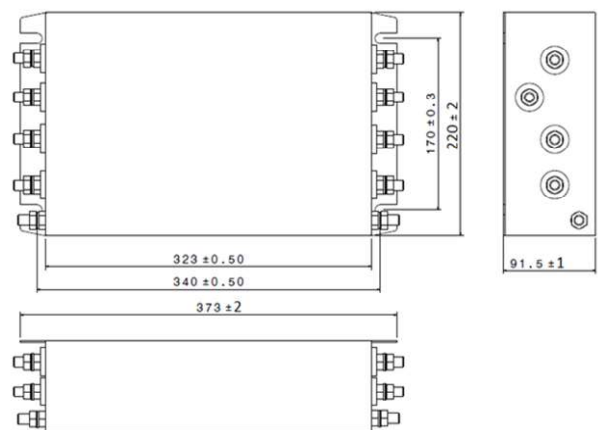

All dimensions in mm; Tolerances according to ISO2768-m

Insertion Loss - (Common Mode)

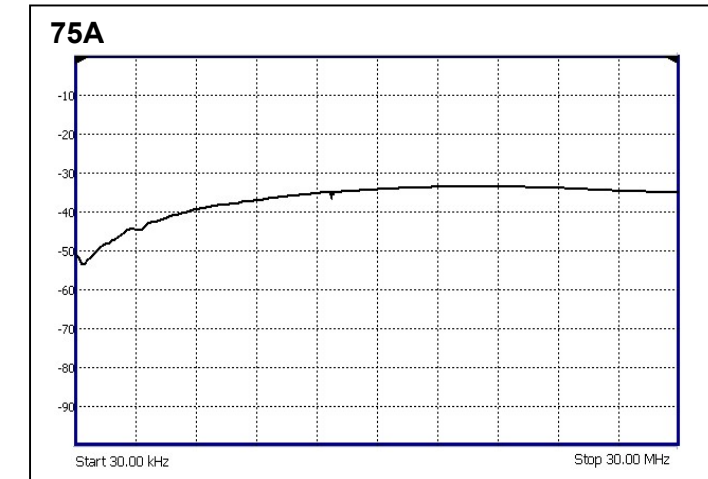
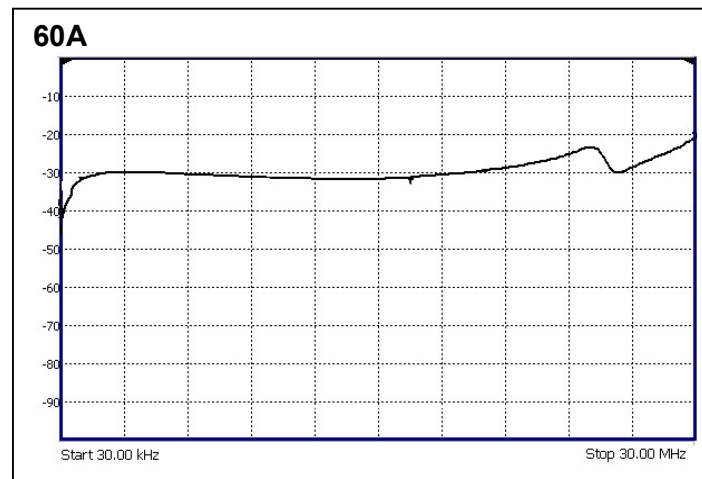
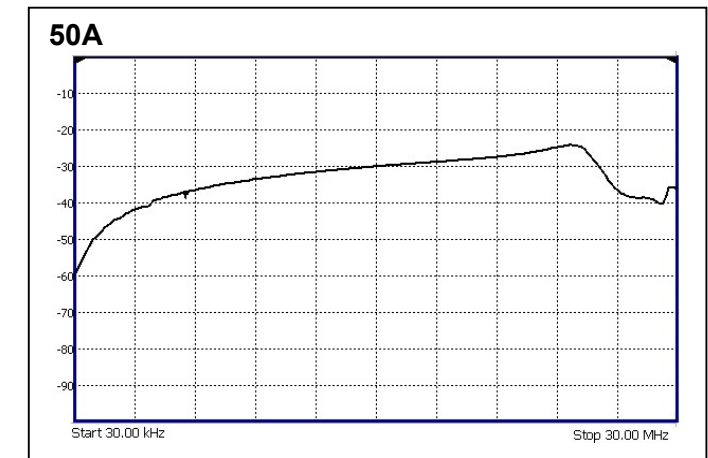
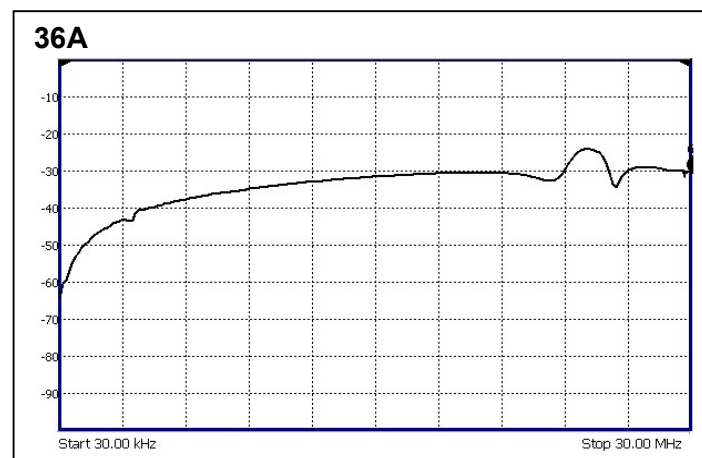
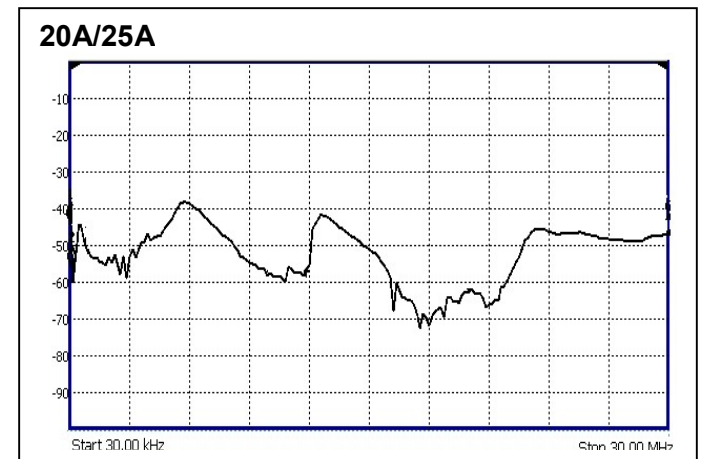
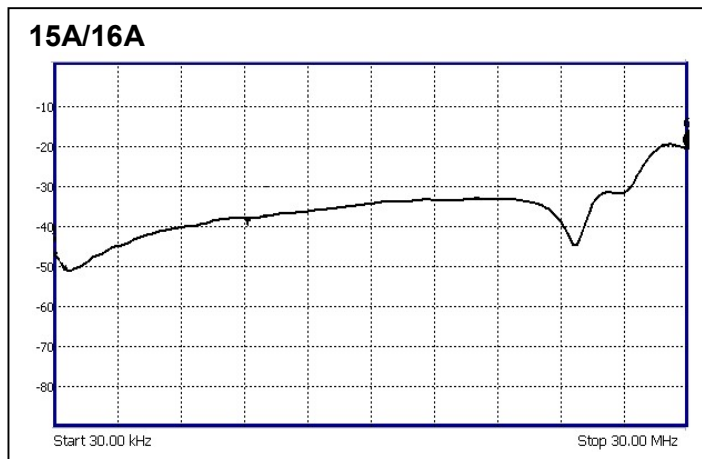
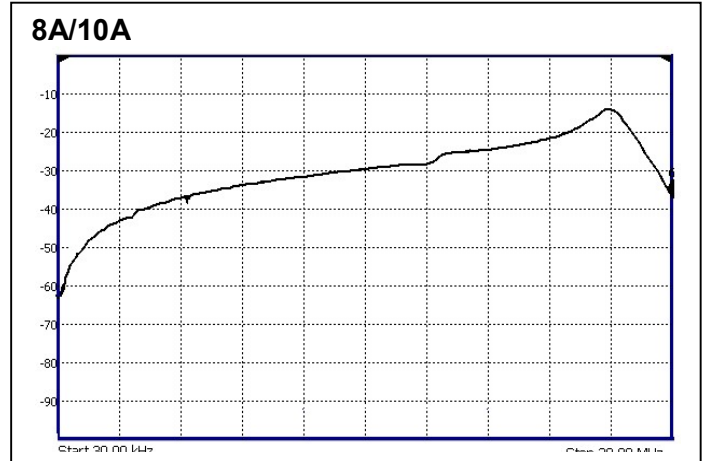
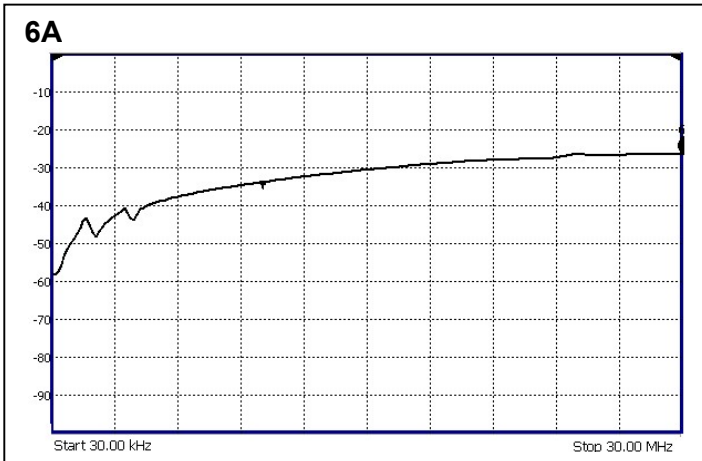

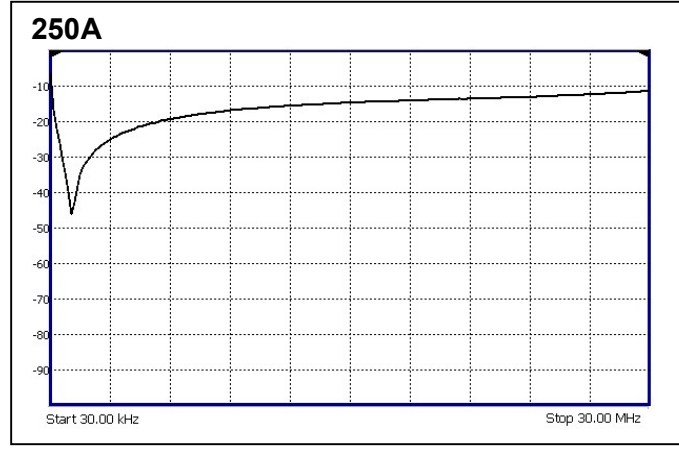
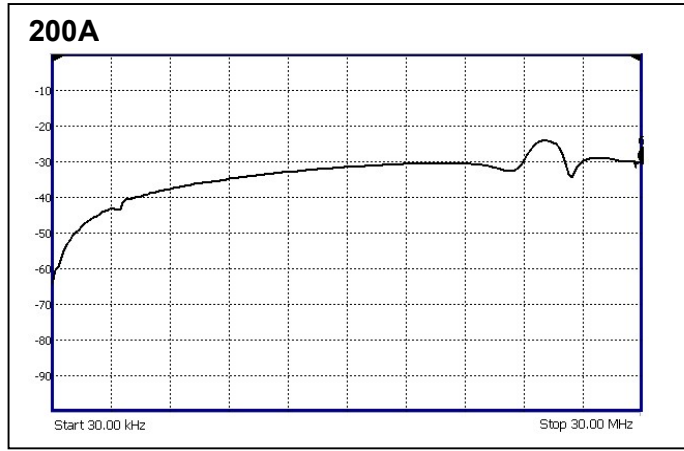
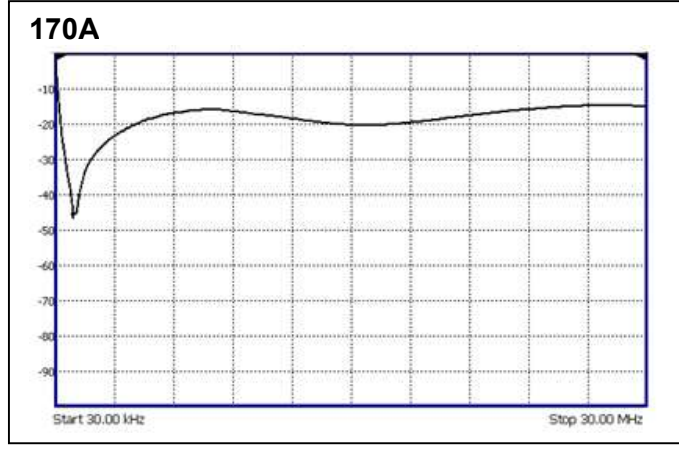
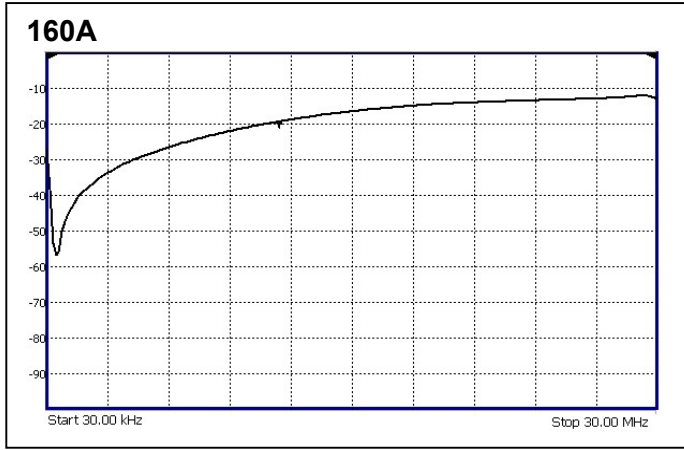
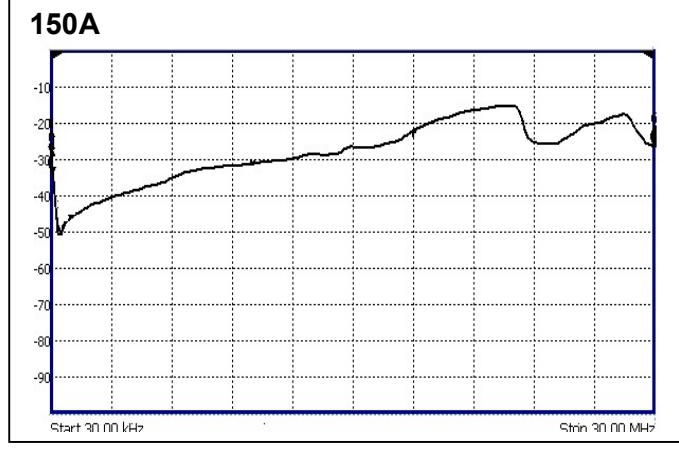
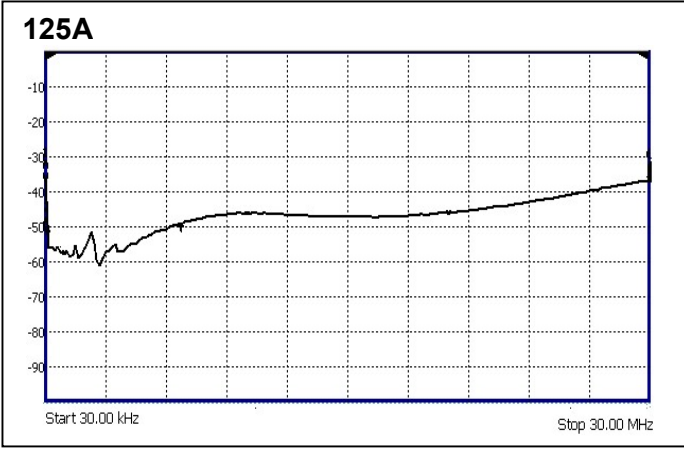
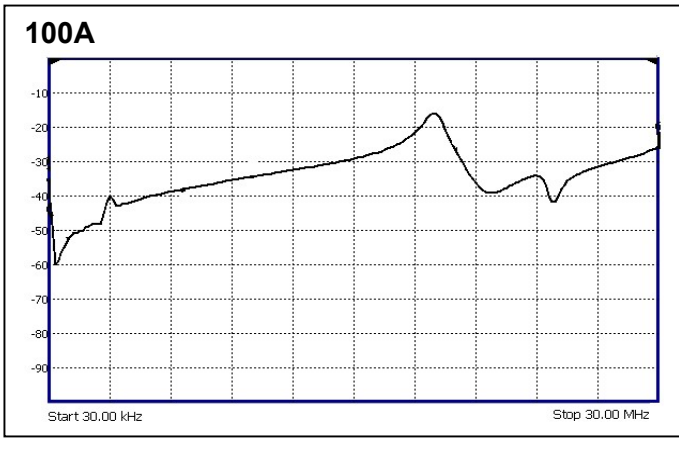
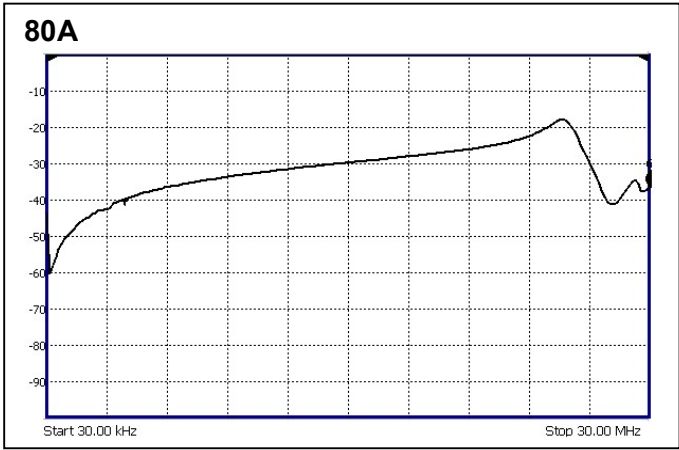

EMI Solutions Private Ltd
 #237-A5, Bommasandra Industrial Area, Bangalore-560099,
 Marketing: +91 80 27836880, Email: marketing@emisindia.com